

INDOASIAN  TM
MAKES SENSE



Glint TM

**WELCOME
CHANGE**

WELCOME CHANGE

Today's India is filled with new experiences. From entertainment to transportation and food, the modern Indian wants to try out all that's new. And every experience, no matter how small, brings you into a new world and changes your lifestyle for the better.

At IndoAsian, we have always derived inspiration

from your needs and are always looking to create products that will serve you best. Our 58 years of service in safeguarding India with protection products, is testament to our belief. By keeping in sight your passion for change, we present to you our all new range of wiring accessories - Glint.

A good-looking package of convenience, flexibility and performance, it brings a spark of change to your lifestyle. Glint will add a shine to your walls, without burning a hole in your pocket!

So go ahead, switch to the brighter side of life. Switch to shine. Switch to Glint and welcome change!

MODULARITY

Discover the magic of a modular range with Glint. Designed to perfection, its curved edges and screw-less finish will light up your rooms. The gleaming white colour sparks style, while the glossy finish brightens every wall, no matter what the colour. Its modularity gives you the convenience to install it at the snap of your fingers; it's hassle-free and also easy. With Glint, you can enjoy both ease of installation, and the charm of simplicity, at the same time.



SAFETY

We know that the safety of your loved ones comes first. That's why all our Glint switches are fire-retardant, and the sockets have safety shutters, making them shockproof. Compatible with all plugs, Glint sockets also come with a special feature of pencil-free operation, which ensures freedom from scratches and marks, and most importantly, guarantees peace of mind.



QUALITY

Good looks demand great quality. Glint switches are made of quality PC material and components that add a glossy finish to all your walls, no matter what the colour. Its UV-resistant material ensures that the brightness lasts, and never grows dull. And with an ISI certification you can be sure that along with the good looks, you are also guaranteed complete safety.



EASY IDENTIFICATION

A modern range comes with modern technology.

Our Glint regulators come with a special laser marking that makes identification easy and adds to the beauty of the design.

And guess what, it lasts even longer than printed markings!



FLEXIBILITY

Glint, the all-new modular range, offers you the freedom of flexibility. You can customise the plates as per your convenience or even leave a blank module or two to replace in the future. There's no need to change the entire unit; instead just replace the blank module with the required switch or socket. Save on time, save on money.



RANGE

Glint offers a wide spectrum of products ranging from switches and sockets, to RJ 11, RJ 45, buzzers, 32 DP, and much more. The entire Glint range is UV-resistant, ensuring that your walls stay gleaming, always.



6A SWITCH



MULTISTANDARD SOCKET
6/10/13A-250V, 15A-127V



6A BELL PUSH
WITH INDICATOR



32A DP SWITCH
WITH INDICATOR



FAN STEP
REGULATOR 100W



LIGHT DIMMER 400W



TELEPHONE
SOCKET RJ 11



COMPUTER
SOCKET RJ 45



TV SOCKET



BUZZER 230V

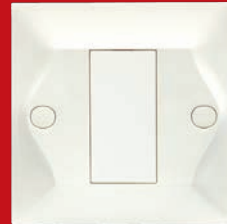

BLANK PLATE



16A POWER UNIT FOR AC AND GEYSER

VALUE FOR MONEY



Glint is a modular range that brightens up your walls with a gleaming white colour that complements all hues, while transforming your home with its modern looks. It offers quality as well as convenience, and most importantly, does so at an affordable price.

EASE OF INSTALLATION

Modular switches, while being flexible and good-looking, save more than half your installation time. The Glint modular range is very easy to install. With just a simple mechanism they'll adorn your walls even before you know it.

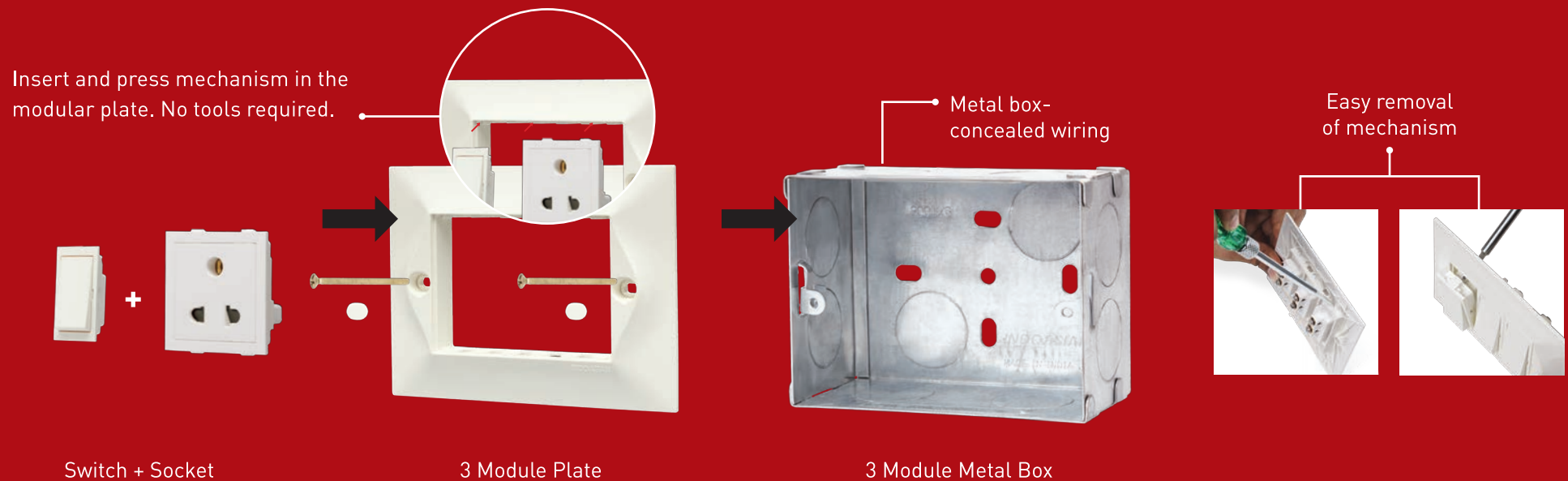

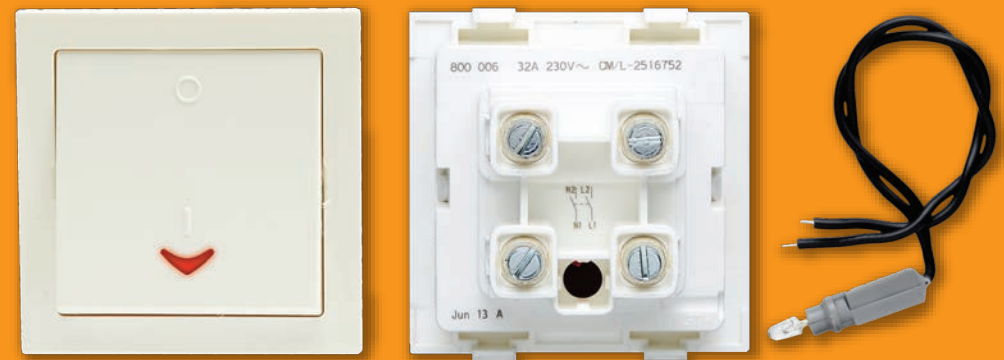

LED INDICATOR

The Glint modular range also offers switches with LED indicators. All LED indicator switches are long-lasting and use less electricity. They indicate the ON/OFF position of the switches and also their working condition.





Switches

	Cat Ref.	Description	Module	Pack
	800000	6A 1-way Switch	1	1/10/200

	Cat Ref.	Description	Module	Pack
	800001	6A 2-way Switch	1	1/10/200

	Cat Ref.	Description	Module	Pack
	800002	16A 1-way Switch	1	1/10/100

	Cat Ref.	Description	Module	Pack
	800003	16A 2-way Switch	1	1/10/100

	Cat Ref.	Description	Module	Pack
	800005	20A DP Switch	2	1/10/50

	Cat Ref.	Description	Module	Pack
	800006	32A DP Switch	2	1/10/50

	Cat Ref.	Description	Module	Pack
	800007	6A Bell Push with Indicator -1M	1	1/10/100

	Cat Ref.	Description	Module	Pack
	800008	6A Bell Push with Indicator -2M	2	1/10/100

Switches with Indicator

	Cat Ref.	Description	Module	Pack
	800004	16A 1-way Switch with Indicator	1	1/10/100

Sockets

	Cat Ref.	Description	Module	Pack
	800020	6A 3 Pin Universal Socket	2	1/10/100

Sockets / Telephone Socket / Computer & TV Sockets

	Cat Ref.	Description	Module	Pack
	800021	10A Euro US Socket	1	1/20/100

	Cat Ref.	Description	Module	Pack
	800022	6/16A 3 Pin Socket	2	1/10/50

	Cat Ref.	Description	Module	Pack
	800023	Multistandard Socket 6/10/13A-250V, 15A-127V	2	1/10/100

	Cat Ref.	Description	Module	Pack
	800030	Telephone Socket RJ11	1	1/20/100

	Cat Ref.	Description	Module	Pack
	800031	Computer Socket RJ45	1	1/20/100

	Cat Ref.	Description	Module	Pack
	800032	TV Socket	1	1/20/100

Buzzer / Fan Step Regulator / Power Unit / Indicator

	Cat Ref.	Description	Module	Pack
	800040	Buzzer - 230V	1	1/20/100

	Cat Ref.	Description	Module	Pack
	800041	Fan Step Regulator 100W	1	1/10/100

	Cat Ref.	Description	Module	Pack
	800043	Fan Step Regulator 100W - 2M	2	1/10/100

	Cat Ref.	Description	Module	Pack
	800025	16A Power Unit for AC & Geyser	4	1/1/5

	Cat Ref.	Description	Module	Pack
	800033	Flat Indicator Red	1	1/20/100

Light Dimmer

	Cat Ref.	Description	Module	Pack
	800042	Light Dimmer 400W	1	1/10/100

	Cat Ref.	Description	Module	Pack
	800062	2 Module Plate	2	1/10/100

Blank Plates / Screw Caps

	Cat Ref.	Description	Module	Pack
	800051	1 Module Blank Plate	1	1/20/200

	Cat Ref.	Description	Module	Pack
	800063	3 Module Plate	3	1/10/100

	Cat Ref.	Description	Module	Pack
	800052	2 Module Blank Plate	2	1/10/100

	Cat Ref.	Description	Module	Pack
	800064	4 Module Plate	4	1/10/100

	Cat Ref.	Description	Module	Pack
	800059	Screw Caps*	-	1/10/100

	Cat Ref.	Description	Module	Pack
	800066	6 Module Plate	6	1/5/50

* 1 Pack contains Ten piece of Screw Caps

Modular Plates-White colour

	Cat Ref.	Description	Module	Pack
	800061	1 Module Plate	1	1/10/100

	Cat Ref.	Description	Module	Pack
	800067	8 Module Plate (Vertical)	8	1/5/25

	Cat Ref.	Description	Module	Pack
	800068	8 Module Plate (Horizontal)	8	1/5/50

Modular Plates-White colour

	Cat Ref.	Description	Module	Pack
	800065	12 Module Plate	12	1/5/25

	Cat Ref.	Description	Module	Pack
	800069	16 Module Plate	16	1/5/25

	Cat Ref.	Description	Module	Pack
	800070	18 Module Plate	18	1/5/25

	Cat Ref.	Description	Module	Pack
	800174	Metal Flush Box 4 Module	4	1/0/40

	Cat Ref.	Description	Module	Pack
	800176	Metal Flush Box 6 Module	6	1/0/40

	Cat Ref.	Description	Module	Pack
	800177	Metal Flush Box 8 Module (Vertical)	8	1/0/20

	Cat Ref.	Description	Module	Pack
	800178	Metal Flush Box 8 Module (Horizontal)	8	1/0/40

Flush Boxes-Metal

	Cat Ref.	Description	Module	Pack
	800172	Metal Flush Box 1 & 2 Module	1/2	1/0/40

	Cat Ref.	Description	Module	Pack
	800173	Metal Flush Box 3 Module	3	1/0/40

	Cat Ref.	Description	Module	Pack
	800175	Metal Flush Box 12 Module	12	1/0/10

	Cat Ref.	Description	Module	Pack
	800179	Metal Flush Box 16 Module	16	1/0/10

Flush Boxes-Metal

	Cat Ref.	Description	Module	Pack
	800180	Metal Flush Box 18Module	18	1/0/10

	Cat Ref.	Description	Module	Pack
	800187	Plastic Surface Box 8 Module (Vertical)	8	1/0/15

Surface Boxes

	Cat Ref.	Description	Module	Pack
	800182	Plastic Surface Box 1 & 2 Module	1/2	1/0/50

	Cat Ref.	Description	Module	Pack
	800188	Plastic Surface Box 8 Module (Horizontal)	8	1/0/10

	Cat Ref.	Description	Module	Pack
	800183	Plastic Surface Box 3 Module	3	1/0/35

	Cat Ref.	Description	Module	Pack
	800185	Plastic Surface Box 12 Module	12	1/0/10

	Cat Ref.	Description	Module	Pack
	800184	Plastic Surface Box 4 Module	4	1/0/25

	Cat Ref.	Description	Module	Pack
	800189	Plastic Surface Box 16 Module	16	1/0/10

	Cat Ref.	Description	Module	Pack
	800186	Plastic Surface Box 6 Module	6	1/0/10

	Cat Ref.	Description	Module	Pack
	800190	Metal Surface Box 18 Module	18	1/0/10

Dimensions

Cover Plates

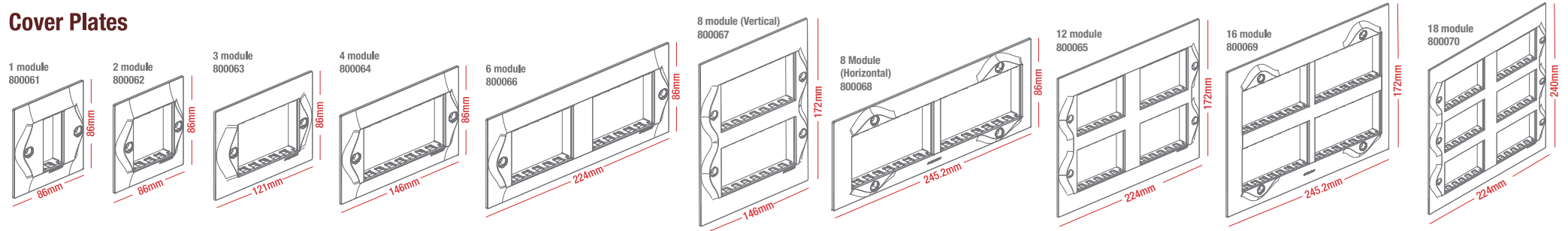



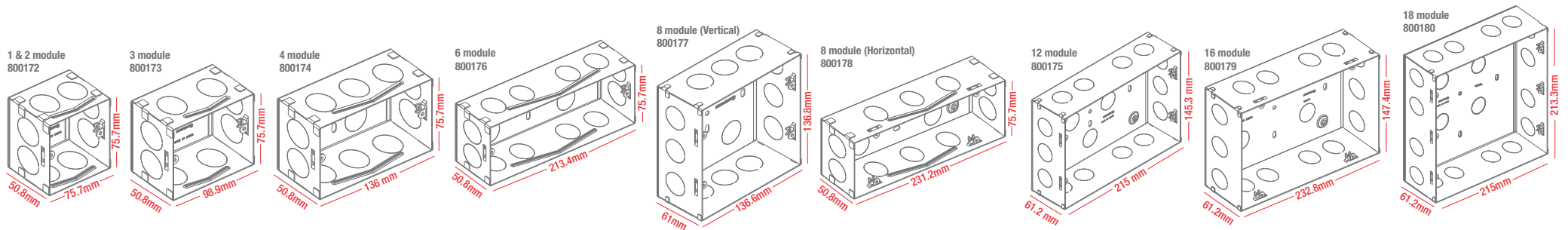

Flush Boxes-Metal

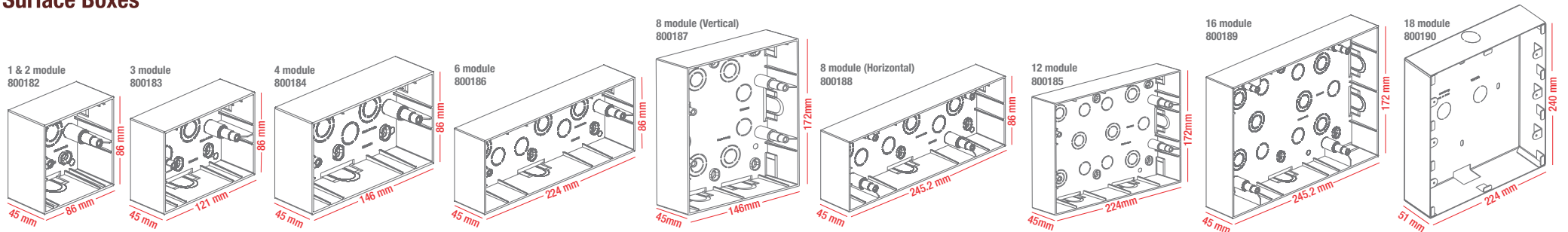

Surface Boxes

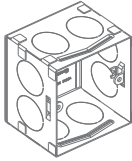
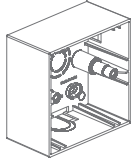
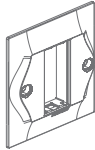

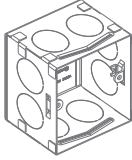
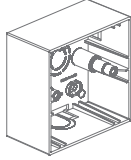
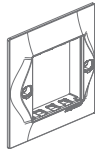
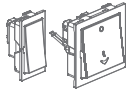
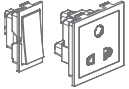
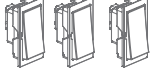
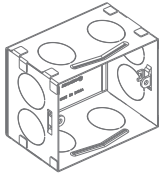
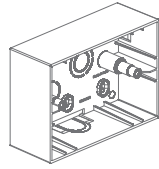
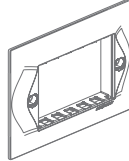
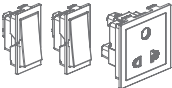
Selection Chart

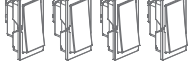
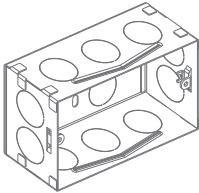
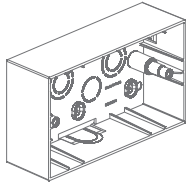
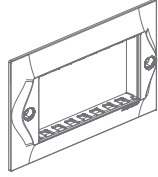
Module	Flush Boxes-Metal	Surface Boxes-Plastic	Cover Plates
	L x W x H	L x W x H	L x W x H
1 Module 	800172 (1 & 2 Module) 75.7 x 75.7 x 50.8 	800182 86 x 86 x 45 	800061 86 x 86  1 M
2 x 1 Module  2 Modules 	800172 (1 & 2 Module) 75.7 x 75.7 x 50.8 	800182 86 x 86 x 45 	800062 86 x 86  2 M
1 + 2 Modules  1 + 2 Modules  3 x 1 Module 	800173 (3 Module) 98.9 x 75.7 x 50.8 	800183 121 x 86 x 45 	800063 121 x 86  3 M
1 + 1 + 2 Modules  2 + 2 Modules  4 x 1 Module 	800174 (4 Module) 136 x 75.7 x 50.8 	800184 146 x 86 x 45 	800064 146 x 86  4 M

Selection Chart

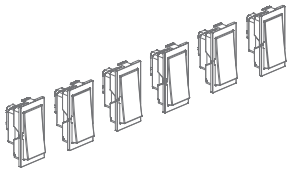
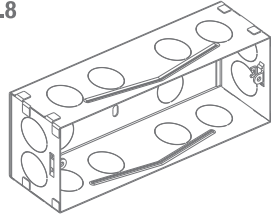
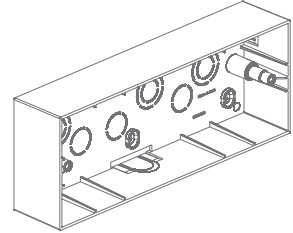
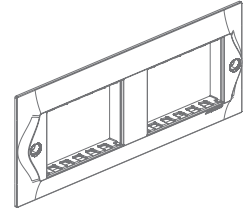
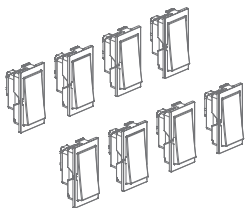
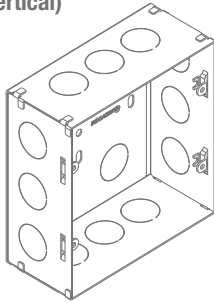
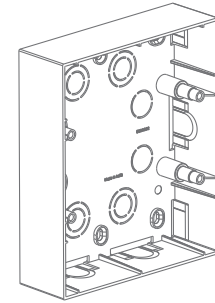
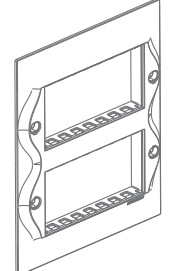
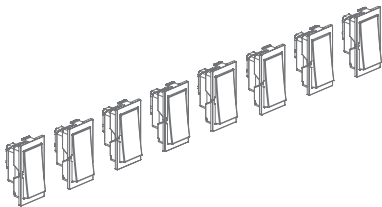
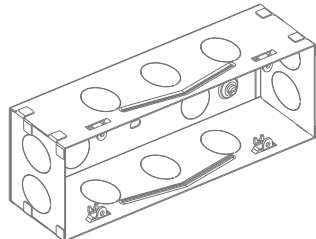
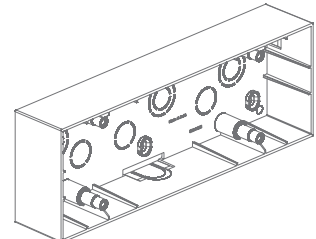
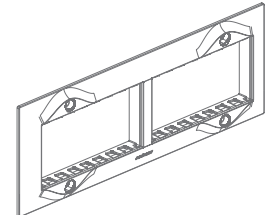
Module	Flush Boxes-Metal	Surface Boxes-Plastic	Cover Plates
	L x W x H	L x W x H	L x W x H
<p>6 x 1 Module</p> 	<p>800176 (6 Module) 213.4 x 75.7 x 50.8</p> 	<p>800186 224 x 86 x 45</p> 	<p>800066 224 x 86</p>  <p>6 M</p>
<p>8 (2 row x 4) Modules</p> 	<p>800177 (8 Module-Vertical) 136.6 x 136.8 x 61.2</p> 	<p>800187 146 x 172 x 45</p> 	<p>800067 146 x 172</p>  <p>8 M</p>
<p>8 x 1 Module</p> 	<p>800178 (8 Module-Horizontal) 231.2 x 75.7 x 50.8</p> 	<p>800188 245.2 x 86 x 45</p> 	<p>800068 245.2 x 86</p>  <p>8 M</p>

Selection Chart

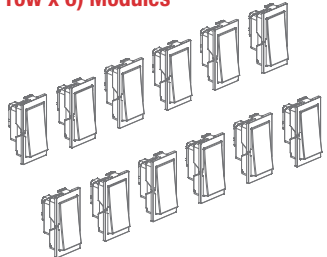
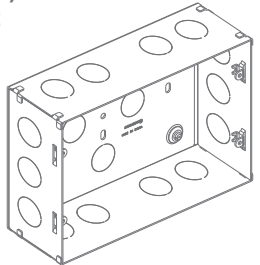
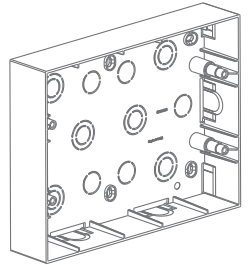
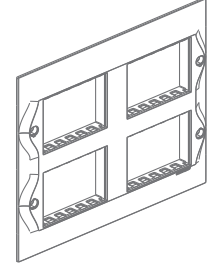
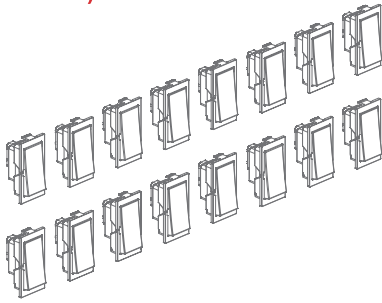
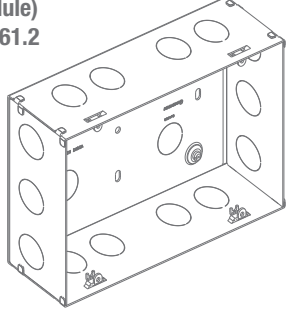
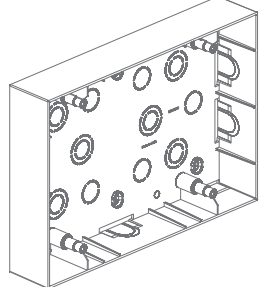
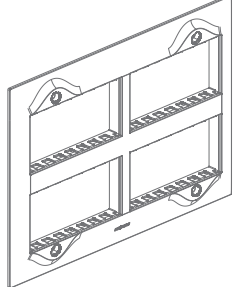
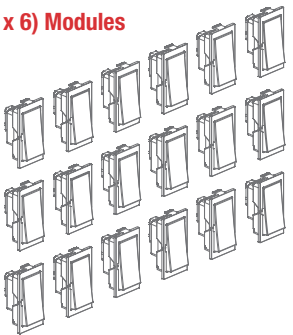
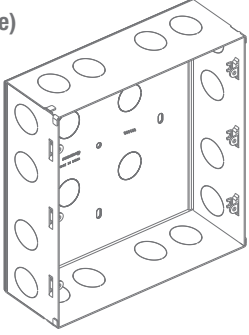
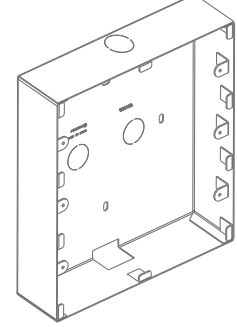
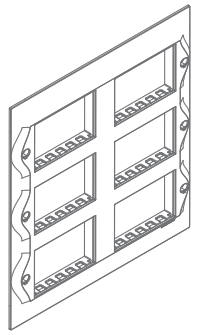
Module	Flush Boxes-Metal	Surface Boxes	Cover Plates
	L x W x H	L x W x H	L x W x H
<p>12 (2 row x 6) Modules</p> 	<p>800175 (12 Module) 215 x 145.3 x 61.2</p> 	<p>800185 224 x 172 x 45</p> 	<p>800065 224 x 172</p>  <p>12 M</p>
<p>16 (2 row x 8) Modules</p> 	<p>800179 (16 Module) 232.8 x 147.4 x 61.2</p> 	<p>800189 245.2 x 172 x 45</p> 	<p>800069 245.2 x 172</p>  <p>16 M</p>
<p>18 (3 row x 6) Modules</p> 	<p>800180 (18 Module) 215 x 213.3 x 61.2</p> 	<p>800190 224 x 240 x 51</p> 	<p>800070 224 x 172</p>  <p>18 M</p>

CORPORATE OFFICE: V. J. Business Towers, A-6, 1st Floor, Sector-125, Noida-201301, U.P., India. Ph.: +91-0120-3305100
E-mail: sales@indoasian.com, international@indoasian.com Website: www.indoasian.com

CUSTOMER CARE SUPPORT EXECUTIVE: V. J. Business Towers, A-6, 1st Floor, Sector-125, Noida-201301, U.P., India.
Ph.: +91-0120-3305111 E-mail: feedback@indoasian.com

NORTH

Regional Sales office

DELHI NCR

V. J. Business Towers
A-6, Ground Floor,
Sector-125, Noida-201301
Ph.: 0120-3365300
E-Mail: in-delhi-office@indoasian.com

Branch office

CHANDIGARH

S.C.O.-11, 2nd Floor,
Sector-26, Madhya Marg,
Chandigarh-160002
Ph.: 0172-3934651
E-Mail: in-chandigarh-office@indoasian.com

Branch office

JAIPUR

433, 4th Floor, Ganpati Plaza,
M. I. Road,
Jaipur-302001
Ph.: 0141-4113528
E-Mail: in-jaipur-office@indoasian.com

Branch office

LUCKNOW

301, 3rd Floor, Chintel House,
Station Road,
Lucknow-226001
Ph.: 0522-4013210
E-Mail: in-lucknow-office@indoasian.com

SOUTH

Regional Sales office

BANGALORE

787, 1st Floor "Skyline Vista"
15th Cross, 100 Feet Ring Road
J P Nagar 1st Phase
Bangalore-560 078
Tel: 080-46219999
E-Mail: in-bangalore-office@indoasian.com

Branch office

COCHIN

Door No.65/1317, Syda Building,
2nd Floor, Kaloor-Kadavanthra Road,
Kaloor, Ernakulam District,
Kochi-682017 (Kerala)
Ph.: 0484-4055581-88
E-Mail: in-cochin-office@indoasian.com

Branch office

COIMBATORE

Door No. 83,
Dr. Nanjappa Road,
Coimbatore-641018
Ph.: 0422-2302715
E-Mail: in-coimbatore-office@indoasian.com

Branch office

CHENNAI

No.5, 1st Floor, Mahalingapuram Main Road,
Nungambakkam,
Chennai-600034
Ph.: 044-28172096, 28170527
E-Mail: in-chennai-office@indoasian.com

HYDERABAD

312, 3rd Floor,
Amrutha Estates, Himayath Nagar,
Hyderabad-500029
Ph.: 040-66742425
E-Mail: in-secunderabad-office@indoasian.com

WEST

Regional Sales office

MUMBAI

401 & 408, K.P. Arrum,
Marol Morshi Road, Andheri East,
Mumbai-400059
Ph.: 022-61035800
E-Mail: in-mumbai-office@indoasian.com

Branch office

AHMEDABAD

102, 1st Floor, Shivalik High Street,
Near Mansi Circle, Vastrapur,
Ahmedabad-380015
Ph.: 079-29701351-53
E-Mail: in-ahmedabad-office@indoasian.com

Branch office

INDORE

202, KK Bafna Arcade,
Janjeerwala Square, Race Course Road,
Indore-452001
Ph.: 0731-4064064
E-Mail: in-indore-office@indoasian.com

Branch office

PUNE

1307, 4th Floor, Rajadwar Building,
Off. J. M. Road, Shivaji Nagar,
Pune-411005
Ph.: 020-60500440
E-Mail: in-pune-office@indoasian.com

EAST

Regional Sales office

KOLKATA

"Raikva Building" Room No. 8, 2nd Floor,
3A Ram Mohan Garden Lane,
Beliaghata E.M.Bypass, Kolkata-700010
Ph.: 033-66041503
E-Mail: in-kolkata-office@indoasian.com