

h3+ moulded cases circuit breaker

# Guaranteed protection



**:hager**



**The reliable  
partner for  
intelligent  
solutions.**

# Under one roof

Members of Hager Group

:hager

**B.**  
Berker

**ELCOM.**

**DAITEM**

**diagral**

**EFEN** 

**BOCCHIOTTI**

## One family

The world is changing, and we are changing with it. As a family company, we have grown steadily over the last sixty years to become a reliable partner to expert technicians and electrical wholesalers around the world. All while remaining true to ourselves and to our values. And so we continue today, with a number of well-known brands – each with their own distinctive strengths – working together under the Hager Group umbrella.



**Hager Forum** in Obernai, France, is a place where we can work with customers and partners to shape the future. That makes it a perfect symbol of the innovative power of Hager Group.

**hagergroup**

## Your trust

As a partner and customer, you can choose from the entire range of products and services offered by every member of our brand family. Our new corporate image highlights our shared strengths even more clearly. From now on, each of our brands will be easily recognisable as a 'Member of Hager Group'. The new corporate image also involves some colour and design changes. Our core promise remains the same: we will always work with you to succeed together.

## Our strengths

We have huge opportunities ahead. The upcoming modernisation of existing buildings, intelligent building technology, digital services, new energy sources and technologies – all of this opens up new, exciting potential for you and for us. At the same time, business requirements are becoming more and more complex. That's why it's so important for you to have Hager Group specialists supporting you with all of their expertise. Together, we are stronger. Together, we will overcome the complex challenges of our time with simple, impressive solutions – just as we have been doing for the last six decades.

# E3

Global warming, a shortage of natural resources, social cohesion and the transition to renewable energy: there are many challenges facing businesses and society today. Hager Group is pursuing a variety of initiatives to promote sustainable development with its “E3” approach.

# Environ

## **E for Environment**

We work continuously to reduce our carbon footprint. Our priorities include optimising the transport of our products and cutting the amount of energy we use in production to further reduce our Carbon footprint.



# Ethics

## **E for Ethics**

We need skilled, motivated and healthy employees in order to offer our customers the best services and products. That's why we provide all our team members with a safe, healthy working environment, support their professional growth and offer them opportunities for further development. We also promote diversity and adherence to an Ethics Code throughout the company.

# ment

# Energy

## **E for Energy**

Hager Group helps its customers to save energy intelligently. We also analyse and optimise our products' environmental performance throughout development and production. By providing a detailed environmental profile for most of our products, we can be fully transparent with our customers and ourselves.

Design at Hager

# In-depth engineering

Staying close to our customers has always been our priority at Hager Group. We're always ready to listen to customers and work towards joint solutions. It's part of our DNA.



Erwin van Handenhoven,  
Hager Group Design Studio Director

Our designs create an intelligent connection between the product and the end user, much like Hager brand itself. We work on the principle of in-depth engineering, which means that, for us, getting to grips with the emotional side of our products is just as important as the technical side of things. Only then can we create solutions that appeal to our customers.

As a provider of electrical solutions, we operate in an industry where design creates added value. At Hager Group, it has been our mission for a number of years to bring together design and technology. From the very beginning, our development teams work closely with our industrial designers, involving customers in the process, to create unique, appealing products that anyone would want to have.



“For us, getting to grips with the emotional side of our products is just as important as the technical side of things. Only then can we create solutions that appeal to our customers.”

We aim to recognise the needs of the end user and to ensure that any resulting design considerations are incorporated in the product or digital application right from the early stages of the development process. As a result, we are able to develop and roll out meticulously designed solutions. This is what makes Hager brand: solutions that are systematically tested by end users, who can then give us feedback about their experience.

We want to create sophisticated products that are just as refined as they are safe and simple. The day-to-day work of our teams revolves around our ability to offer user-friendly, innovative, efficient, aesthetically pleasing, contemporary solutions to our customers.

In a sense, our design is our signature; it is our DNA. It unites all of the products in our catalogue and represents the essence of our brand.

#### Outstanding design

We strive for excellence in every field. In the area of design, our efforts are regularly recognised by international awards that assess products based on aesthetics, ergonomics, ethics and emotion. We have been honoured to receive a number of awards over the years; most recently for our gallery range, which was launched in 2018 in France. We have also received recognition for witty, our charging stations for electric vehicles. Our collection of awards includes a Red Dot Design Award, a Good Design Award (Chicago), a Janus Industry Award, which is awarded by the French Institute of Design, an iF Design Award and a German Design Award.



Berker R.8

Protect and measure

# Premium performance

Energy efficiency lies at the heart of present and future building construction. Energy performance relies on the quality of the networks transmitting the energy: sizing, maintenance and monitoring. And to guarantee maximum reliability in electrical installations, low voltage panels must incorporate solutions renowned for their simplicity and efficiency.



**40%**  
of energy consumption  
is accounted for by  
buildings.

Energy is also believed to make up 40 % of the costs generated throughout a building's life cycle. Faced with the inevitable rise in energy costs, the challenge is clear: manage consumption to bring down bills. Creating intelligent buildings means optimising and streamlining their consumption based on usage.

## **Hager's h3+ anticipates and incorporates the standards governing energy distribution in buildings.**

The new IEC 60 364 standard states that energy must be used as efficiently as possible. It also highlights the importance of adopting an energy efficiency approach right from the building design stage, on a par with safety and commissioning rules. It classifies energy performance in new buildings on five levels. The IEC 60 364 standard includes recommendations and a continuous improvement methodology, along with verification steps for the results obtained. It also requires an electrical energy management system to be integrated in the installation. The system must be able to manage various energy sources, monitor energy usage and take account of usage habits within the building. The standard focuses on three points: minimising energy loss, using energy at the right time and at the lowest cost, and maintaining an optimal level of availability and performance.

The Hager solution also addresses buildings involved in the ISO 50001 certification process, which involves the creation of an energy consumption improvement plan. It responds to the applicable decree aimed at reducing energy consumption in existing buildings.

**The new generation of Hager h3+ moulded case circuit breakers guarantees reliable protection against overloads and short circuits, as well as targeted, integrated energy monitoring for all low voltage distribution systems.**



**Performance  
Service continuity  
Energy management**

U2.4  
TEST 0 2016

hager

Three small monitors at the top: DISPLAY 012, DISPLAY 014, DISPLAY 016.

hager logo and a red indicator light.

QG1

Terminal blocks and modules.

hager logo at the bottom left.

hager

Terminal blocks and modules.

hager logo at the bottom left.

C2 A3 A2 B5

C3 B6 C8 CKT 800 KOCH

C4 C5 C1 B1

hager

h3+, the moulded case circuit breaker

# Your installation is under control

The size of residential and commercial buildings determines the energy requirements. Regulations are becoming increasingly strict. You therefore need effective protection suited to your electrical installation.

The new h3+ moulded case circuit breakers meet these requirements, thanks largely to their breaking capacity of up to 110 kA and their ability to protect, measure, display and communicate with Building Management Systems. As its name implies, the h3+ range offers a broader choice, with trip units, more smart features, and more reliable protection.

**Advanced technology for optimal safety.**

One range. Three versions

# The choice is yours

**From the traditional version to the intelligent connected model: discover the multi-faceted range of h3+ circuit breakers.**

Featuring the compact frame sizes, available from 25 to 630 A with 3 or 4 poles, the h3+ provides superior protection and a breaking capacity up to 110kA.

Equipped with a thermal magnetic or electronic trip unit, the moulded case circuit breaker range offers an accurate benefit: flexible protection settings for all electrical distribution applications.



**NEW**

**h3+/P160**  
**208 variants**

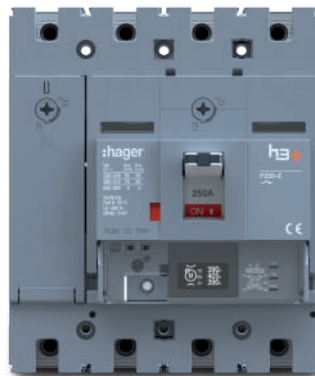

**NEW**

**h3+/P250**  
**254 variants**



**NEW**

**h3+/P630**  
**78 variants**

The new generation of h3+ moulded case circuit breakers is available in two versions: the traditional range for protecting your electrical installations and the energy model for improving the energy efficiency of your buildings.

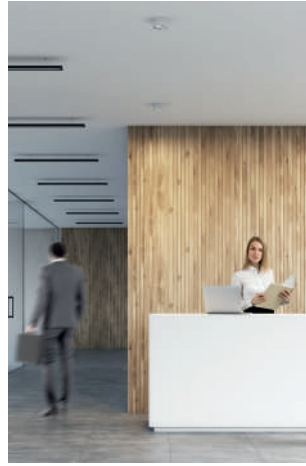

**Multi-site**  
The new h3+ moulded case circuit breakers are ideal for all types of tertiary buildings, including shops, hotels, offices and healthcare establishments.

## 01 Traditional version

Protect

## 02 Energy version

Protect  
Measure, meter  
Display  
Communicate



### agardio.measure

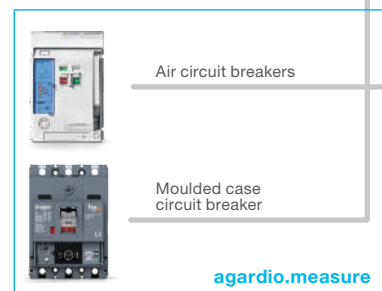
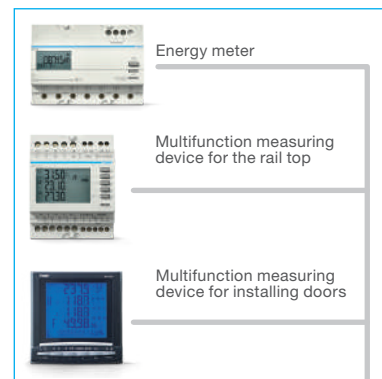

### agardio.manager

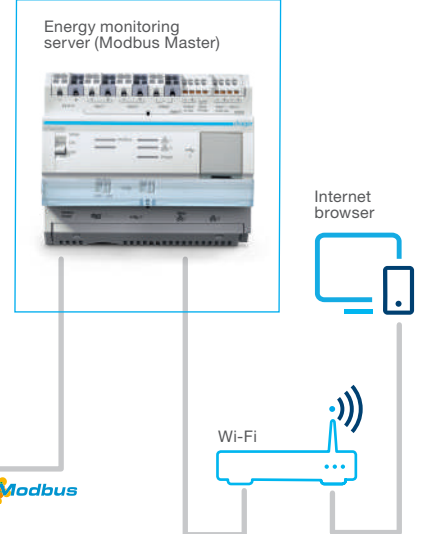

From the circuit breaker to the communication panel, built-in solutions are at the heart of the h3+ offering.

h3+ traditional version

# Guaranteed protection

The new range of moulded case circuit breakers provides solutions suitable for electrical installations in commercial buildings. It offers reliable protection against overloads and short circuits.

The multiple setting options, created by coordinating the protection systems, offer the best possible combinations. This brings a threefold benefit: guaranteeing user and equipment safety under all conditions, ensuring continuity of service and availability of energy in normal operating situations, and, in case of transient faults, reducing the risks to the installation's components.

All products in the new range can be easily integrated in the hager enclosure systems.



- Most compact product on the market with measurement and communication.
- From 25 to 630 A
- Three frame sizes
- Can be mounted on the DIN rail in option up to 250 A
- TM, MAG, LSnl, LSI, LSIG and Energy trip units
- Breaking capacity of 25, 40, 50, 70 and 110 kA at 415 VAC
- 3P3D or 4P4D (neutral adjustable to 0, 50 or 100 %)
- Wide range of auxiliaries and accessories
- Horizontal or vertical installation







## 01 Secure screw

The quarter-turn auxiliary access system saves time when installing the product. The secure screw offers additional comfort.



## 02 Hinged front cover

The front cover offers multiple advantages. It is mounted on hinges. It remains integral with the case once opened, preventing incorrect refitting.



## 03 Auxiliary window

The type of auxiliaries can be seen directly through the windows on the front panel, without removing the cover.

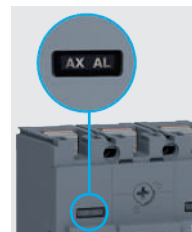

## 04 Integrated padlock

The handle can be directly locked with no need for extra accessories.



All the technical specifications are available in the technical repository and the network calculation software, [hagercad.net](http://hagercad.net).

In addition to the traditional version: h3+ energy version

# In intelligent and connected mode

**Hager is complying with energy efficiency standards by adding new functions to its moulded case circuit breaker range. A Class 1 energy monitoring and communication system compatible with the Modbus RTU protocol can be used to configure the protection parameters, monitor energy consumption and manage alarms.**

## Energy performance

The h3+ moulded case can be coupled with the agardio.manager multi-energy manager, allowing it to be integrated in an energy efficiency environment.

This allows the energy consumption to be displayed centrally, while complying with the IEC 60364, NF 15-100 and ISO 50 001 standards. Class 1 measurement accuracy is guaranteed.

## Service continuity

A specific auxiliary is used to trigger a fault alarm. This function helps prevent a total power outage. The user is notified in advance, allowing the appropriate action to be taken.

## Secure connection

The functions are pre-wired to connectors. The bus connection uses an RJ45 connector, which means there is no risk of incorrect wiring. The power is supplied from the tool and no external source is required.



## 05 Integrated pre-alarm contact

## 06 OLED screen

## 07 Configurable alarm contact

## 08 Communication port



### Greater flexibility

The moulded case circuit breaker can be configured via the built-in screen, the panel display or the configuration tool. In the latter case, the interface used for configuration does not need to be installed since the software operates via the Webserver on your phone, tablet or PC.

### Greater ease of use

Cut programming times for your installation by up to 80 % with the agardio.manager ecosystem. Pre-addressing is already done: a library of products is available in agardio.manager. There is therefore no need to complete the addressing table: you need only name the products.



### Overview

- Over 300 variants
- Intelligent electronic tripping
- Breaking capacity up to 110 kA
- Intelligent programming (h3+ energy only)

# h3+ energy go further

**Measure, meter, communicate: the h3+ energy version can be integrated in the agardio.manager ecosystem, the solution designed by Hager to monitor and manage energy consumption.**

## h3+

**Associated with the agardio.manager ecosystem, the h3+ energy range is at the forefront of a new generation of circuit breakers that combine safety and energy efficiency.**



The h3+ energy moulded case is an adaptable, scalable solution that protects, measures, meters, displays and communicates.



It guarantees Class 1 energy measuring accuracy.

You can use your smartphone, tablet or PC to easily access information on the use and maintenance of the building. Consumption and installation configuration data, alarms and faults can be identified at any time. The h3+ energy moulded case is a scalable solution that protects, measures, meters, displays and communicates.

For bakeries, hotels and residential care homes: you are immediately warned if there is a power outage, enabling you to maintain the cold chain and preserve the quality and comfort of living areas.

# The agardio.manager ecosystem: three in one

01

## Measure and meter

The device collects field-based information on the network and protection.



02

## Centralise

The agardio.manager centralises and feeds back information. This is the heart of the installation.

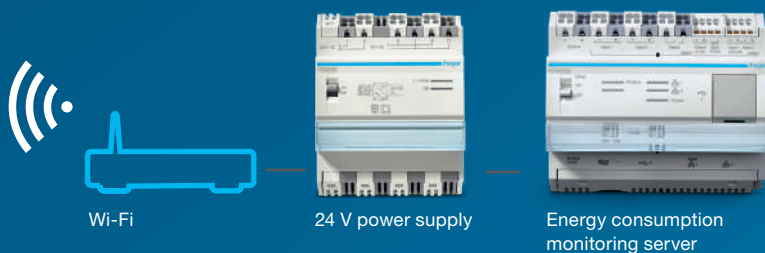

The agardio.manager is a multi-site manager that records, displays and monitors the network quality and energy consumption parameters. It guarantees compliance with the new IEC 60 364 and ISO 50 001 standards.

03

## Display and monitor

The Webserver interface manages the entire system. It provides structured data.



Access via internet browser



# A needs-based approach

## TM

h3+ circuit breakers equipped with magnetothermal trip units are designed for power distribution applications. They are used to protect the conductors and the loads supplied by the transformers or generators, and when the fault current is limited due to impedance caused by the length of the conductors. The settings are made using adjustment dials on the front of the products.

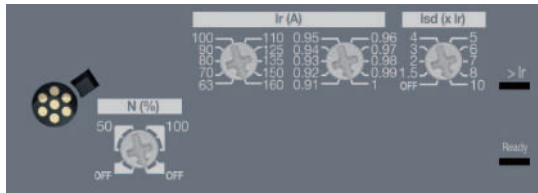
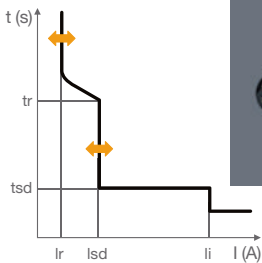
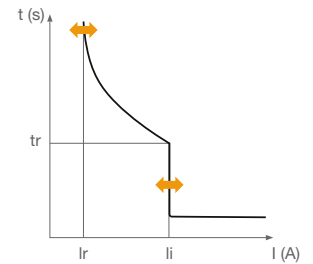

## LSnI trip unit

Designed to protect networks supplied by transformers or generators and for long cables, the LSnI version offers a solution adapted to this type of supply.

## LSI and LSIG trip units

h3+ circuit breakers equipped with LSI or LSIG trip units are designed for power distribution applications for protecting conductors and loads in cases where a wide range of protection settings is required.

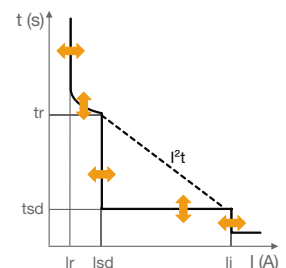
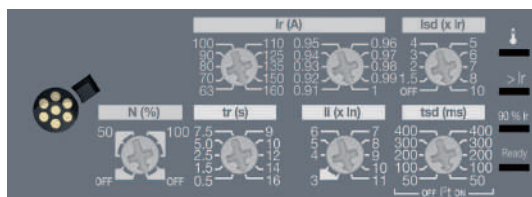

Settings made using adjustment dials are accessible on the front of the products, and enable accurate adjustment of the protection and a trip curve independent of the ambient temperature. The LSIG version offers a protection against the ground fault.

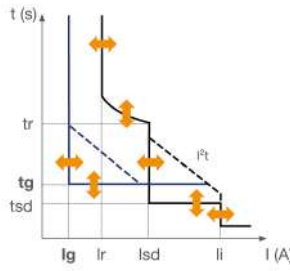

## Energy trip unit

Offering a similar protection than LSIg trip unit, the Energy benefits from a class 1 energy monitoring and communication system compatible with Modbus RTU protocol that will allow them to configure protections parameters, monitor energy consumptions and manage alarms.

## MAG (ICB)

h3+ circuit breakers equipped with magnetic trip units are designed for use in power distribution applications in which only magnetic protection is required. They are mainly used to protect motors associated with a thermal relay and a power switch.

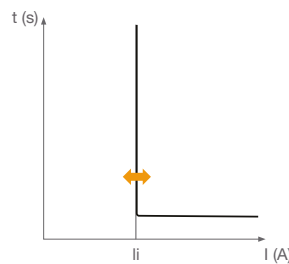

**TM, MAG, LSnI, LSI, LSIg, Energy: six trip unit versions designed to effectively protect your installations and optimize the cost of your switchboards.**

	TM		MAG		LSnI		LSI			LSIg		Energy		
	P160	P250	P160	P250	P160	P250	P160	P250	P630	P250	P630	P160	P250	P630
Breaking capacity	25,40, 50 or 70kA		25,40, 50 or 70kA		25, 40, 50 or 70kA		25, 40, 50 or 70kA			40, 50, 70, 110 kA	25, 40, 50, 70 kA	25, 40, 50 or 70kA		40, 50, 70, 110 kA
Ratings	25 - 160 A	50 - 250 A	25 - 160 A	100 - 250 A	40 - 160 A	40 - 250 A	40 - 160 A	40 - 250 A	250 - 630 A	40, 100, 160, 250 A	250 - 630 A	40 - 160 A	40 - 250 A	250 - 630 A
No. of poles (P) and trip units (D)	3P3D or 4P4D (N: 0 -100% or 0 - 50%)		3P3D or 4P4D		3P3D or 4P4D (N: 0, 50 or 100%)		3P3D or 4P4D (N: 0, 50 or 100%)			3P3D or 4P4D (N: 0, 50 or 100%)		3P3D or 4P4D (N: 0, 50 or 100%)		
RCD add-on block	No	Yes	No	Yes	No	Yes	No	Yes	Yes	Yes	Yes	No	Yes	Yes
Configuration tool												Yes		
Panel display												Yes		
Communicating version												Yes		



## easy to install

Designed for professionals, the h3+ moulded case circuit breaker range is without doubt the best adapted to installation requirements. Compact and ergonomic, the h3+ is particularly easy to integrate in switchboards. Easy commissioning, fast wiring: everything to optimise installation.

### Horizontal or vertical installation

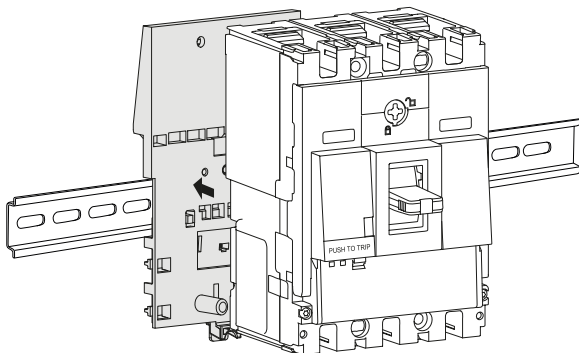

#### Mounting

P160 and P250 can be mounted on DIN rail

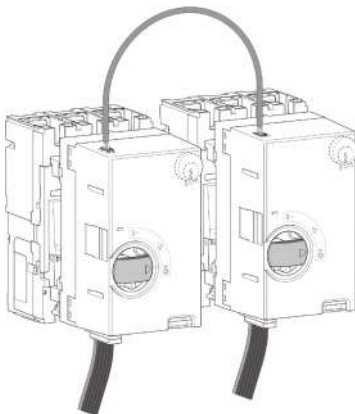

#### Interlocking

Available for frame P160, P250, P630



### 1. RCD add-on block

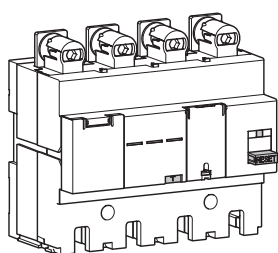

### 2. Connection accessories

#### Connection terminals

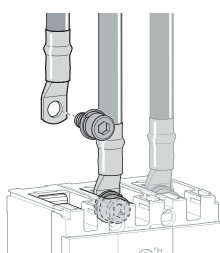

### 3. Terminal enclosures

#### For extended connections

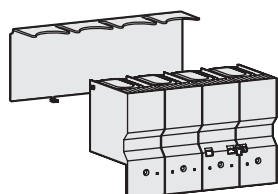

#### For spreaded connections

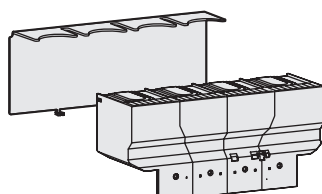

#### For rear connections

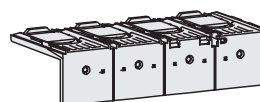

### 4. Auxiliary contacts

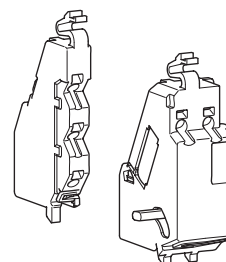

### 5. Control auxiliaries

#### Direct rotary operation

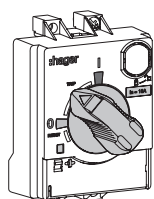

#### External rotary operation

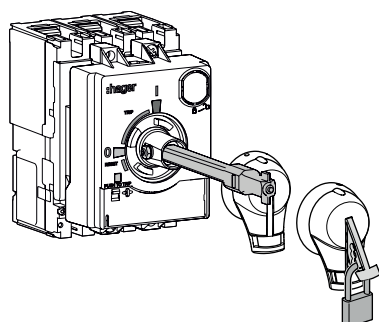

#### Motor operator

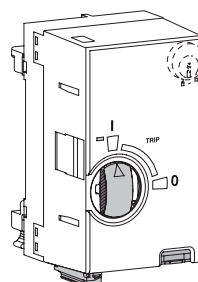

### 6. Locking device

#### Padlocking device



#### Ronis type key device



# Pro-business solutions provider

Hager offers solutions tailored to your business and your requirements. Ranges designed to meet your working requirements: ease, speed, peace of mind.



## Panel builders

Install and monitor your cabinet quickly and with complete peace of mind.

### Advantages:

- Time savings thanks to the front cover
- Quick connection
- Easy adjustment

## Contractors

With easy configuration, connection and setting, and quick case commissioning, the h3+ range saves you a lot of time.

### Advantages:

- Quick commissioning
- Flexible configuration



## End Users

Manage your consumption with agardio.manager. You are kept informed of service continuity and benefit from a scalable solution adapted to the normative environment.

### Advantages:

- Energy optimisation
- Service continuity

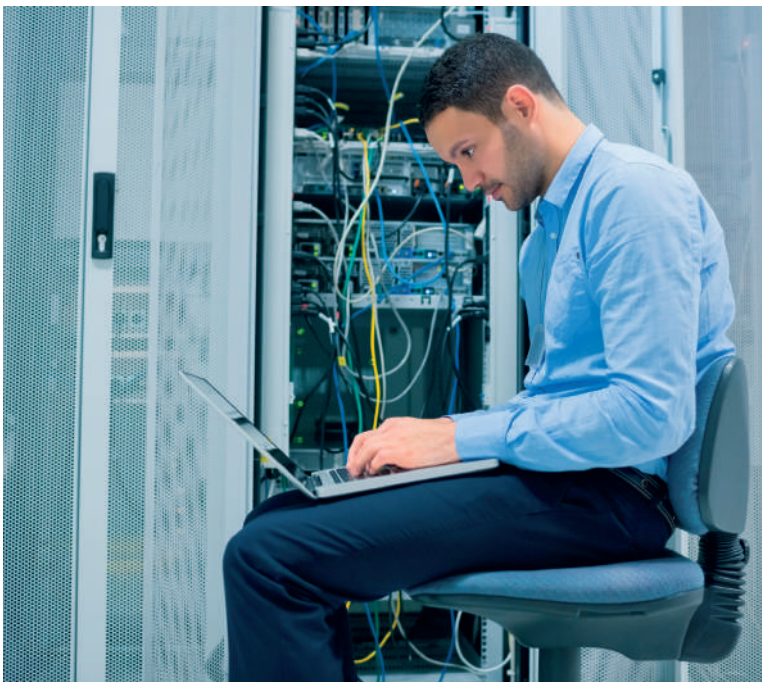

## Integrators

The agardio ecosystem enables you to optimise the integration and commissioning of the solution.

### Advantages:

- Quick, secure connection
- Cut your installation programming time by up to 80 %

# Hager Training, the path to excellence



**Take steps to  
develop your skills**

Votre accès  
formation facilité

**Pass**  
compétences  
entreprise

:hager

**Benefit from three 7-hour training sessions for one  
or more of your employees.**

- €720 incl. tax (2018 prices)
- Valid for one calendar year
- Breakfast included
- Accommodation and travel costs not included.

Easy access to training

**[hager.fr/pass](http://hager.fr/pass)**

# Technical assistance, get answers quickly

Access any information you  
require in a few clicks.



## Manuals

Installation,  
product wiring



## Videos

For commissioning  
a product



## Tutorials

Recommendations,  
configuration,  
settings, etc.

hager.in

[hagerwow@hager.co.in](mailto:hagerwow@hager.co.in)



## FAQ

Answers to all your  
questions



## Retail price

For project costing

## Software

Design and cost your electrical  
installations with **hagercad.T**

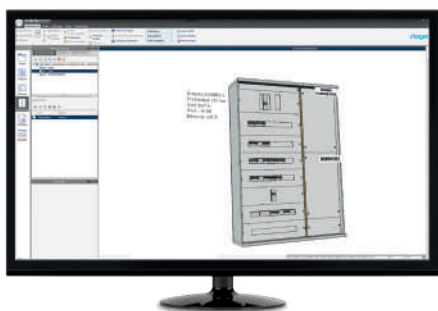



# Always near

## North

Delhi & NCR  
Haryana  
Uttar Pradesh  
Punjab  
Chandigarh  
Jammu & Kashmir  
Rajasthan

## East

West Bengal  
Orissa  
Jharkhand  
Assam

## West

Maharashtra  
Gujarat  
Madhya Pradesh  
Chattisgarh

## South

Tamilnadu  
Karnataka  
Kerala  
Telangana  
Andhra Pradesh

## Our network to serve you better

- 350+ Authorised Channel Partners
- 35+ System Integrators
- 25+ Service Centres



We are also there for you 24 hours:

[hager.co.in](http://hager.co.in)



**Hager Electro Private Limited**

Global Industrial Park  
G. No. 185, Alandi - Ahmednagar Road,  
Phulgaon, Pune-412216  
India

Tel: +91 20 66784500  
Toll free no.: 1800 103 5440  
hagerwow@hager.co.in  
**hager.co.in**

**Mumbai Sales Office:**

WeWork The Masterpiece  
Marol Metro Station  
Marol, Andheri East  
Mumbai-400059  
India

Tel: +91 22 49097185

**Delhi Sales Office:**

B 217 Tower B  
DLF Towers, Jasola  
New Delhi-110025  
India

Tel: +91 11 42548644

**Kolkata Sales Office:**

Office # 506, 5th Floor  
Shantiniketan Building  
8, Camac Street  
Kolkata-700017  
India

**Bengaluru Sales Office:**

WeWork Galaxy  
# 02A129, 43 Residency Rd  
Bengaluru-560025  
India

Tel: +91 80 44451100